

Operation Manual

Dissolved Oxygen

Transmitter / Controller

DO2000/ DO3000/ DO5000/ DO5500

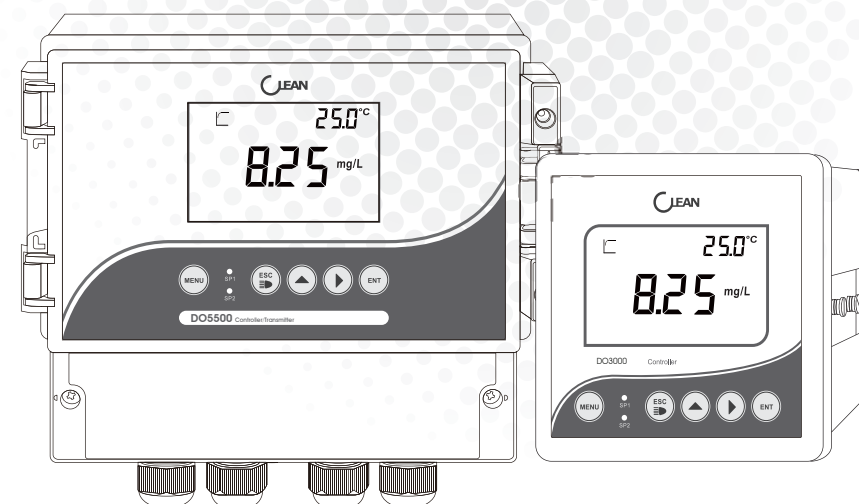

Dissolved Oxygen

Controller / Transmitter (DO2000/DO3000/DO5000/DO5500)

www.cleaninst.com

Customer Service: CS@cleaninst.com

CLEAN INSTRUMENTS

2006, No.511 Tianmu W. Rd. Shanghai 200070, China
11F No.25,Siwei St., Zhonghe Dist.,New Taipei City 23570, Taiwan

www.cleaninst.com

TABLE OF CONTENTS

7.2 Water saturated dissolved oxygen in different temperature

(Atmospheric Pressure 101325Pa 100% RH Salinity 0‰)

temperature°C	dissolved oxygen(mg/L)	temperature°C	dissolved oxygen(mg/L)
0	14.64	20	9.08
1	14.22	21	8.90
2	13.82	22	8.73
3	13.44	23	8.57
4	13.09	24	8.41
5	12.74	25	8.25
6	12.42	26	8.11
7	12.11	27	7.96
8	11.81	28	7.82
9	11.53	29	7.69
10	11.26	30	7.56
11	11.01	31	7.43
12	10.77	32	7.30
13	10.53	33	7.18
14	10.30	34	7.07
15	10.08	35	6.95
16	9.86	36	6.84
17	9.66	37	6.73
18	9.46	38	6.63
19	9.27	39	6.53

1 PREFACE	01
1.1 Before Use	01
1.2 In Use	01
1.3 Safety	01
2 PRODUCT OVERVIEW	02
2.1 Product Features	02
2.2 Technical Parameters	03
2.3 Measurement & Control System	04
2.4 Appearance	05
2.4.1 Display	05
2.4.2 Display Character Table	05
2.4.3 Key Panel	06
2.4.4 LED Indicator	06
2.4.5 Model and Menu	07
2.5 Menu Preview	08
3 INSTALLATION	10
3.1 Installation	10
3.2 Connection Diagram	12
4 CALIBRATION	13
4.1 DO Sensor Calibration	13
5 SET UP	14
5.1 P01 Electrode Factor	14
5.2 P02 Atmospheric Pressure	15
5.3 P03 Process Pressure	15
5.4 P04 Salinity	16
5.5 P05 Display Unit	16
5.6 P06 Temperature Offset	17
5.7 P07 Relay 1	18
5.8 P08 Relay 2	18
5.9 P09 Relay 3	19
5.10 P10 Current Output	20
5.11 P11 485 output	21

5.12 P12 Password 22
 5.13 P13 Factory Defaults 22
 5.14 Current Setup Status Review 23

6 PROTOCOL 24

7 APPENDIX 29

7.1 DO Factory Defaults 29
 7.2 Water saturated dissolved oxygen in different temperature 30

8 GENERAL INFORMATION 31

8.1 Warranty 31
 8.2 Return Of Malfunction Instruments 31
 8.3 Guidelines Or Returning Unit For Repair 31

Model and Function

	PH2000		PH3000		PH5000		PH5500	
Electrode Factor	P01	Page14	P01	Page14	P01	Page14	P01	Page14
Atmospheric Pressure	P02	Page15	P02	Page15	P02	Page15	P02	Page15
Process Pressure	P03	Page15	P03	Page15	P03	Page15	P03	Page15
Salinity	P04	Page16	P04	Page16	P04	Page16	P04	Page16
Display Unit	P05	Page16	P05	Page16	P05	Page16	P05	Page16
Temperature Offset	P06	Page17	P06	Page17	P06	Page17	P06	Page17
Relay 1			P07	Page18	P07	Page18	P07	Page18
Relay 2			P08	Page18	P08	Page18	P08	Page18
Relay 3					P09	Page19	P09	Page19
Current Output	P07	Page20	P09	Page20	P10	Page20	P10	Page20
485 output					P11	Page21	P11	Page21
Password	P08	Page22	P10	Page22	P12	Page22	P12	Page22
Factory Defaults	P09	Page24	P11	Page24	P13	Page24	P13	Page24

7.1 DO Factory Defaults

Item	Corresponding interface	Factory Defaults
Electrode Factor	P-01	80nA
Atmospheric Pressure	P-02	101.3mBar
Process Pressure	P-03	101.3mBar
Salinity	P-04	0.0g/L
Display unit	P-05	
Temperature Offset	P-06	
Relay 1	P-07	40.0% for opening point, 45.0% for closure point
Relay 2	P-08	40.0% for opening point, 45.0% for closure point
Relay 3	P-09	
Current output	P-10	4.00mA corresponds to 000.0%; 20.00mA corresponds to 200.0%
485 output	P-11	
Password	P-12	Factory default: 0000
Factory Defaults	P-13	

Analyze on the data part:

Byte	1	22	3,4
Analyze	Unit type: 3 is for DO	Sensor type: 0 is for 400nA sensor, 1 is for 80nA sensor	Atmospheric pressure compensation unit: mbar
Byte	5,6	7,8	9
Analyze	Process pressure compensation unit: mbar	Salinity Compensation unit: g/L	Display Unit 0 is %; 1 is mg/L
Byte	10	11,12	
Analyze	Temperature compensation type: 0 is NTC22K, 1 is PT1000	Temperature offset value, integer (Default 1 decimal point, unit is °C)	

Unit comparison table:

Data	0	1	2	3	4	5	6
Unit	mV	nA	uA	mA	Ω	KΩ	MΩ
Data	7	8	9	10	11	12	13
Unit	uS	mS	S	PH	°C	°F	Ug/L
Data	14	15	16	17	18	19	20
Unit	Mg/L	g/L	ppb	ppm	ppt	%	mbar
Data	21	22					
Unit	bar	mmHg					

1 PREFACE

1.1 Before Use

Thank you for selecting CLEAN Controller/Transmitter.

Although the Controller / Transmitter use advanced technology and meet the requirements of current safety rules, improper use can still threaten the safety of users, and / or cause harmful influences to factory and other equipments. Therefore, before using the controller / transmitter, relevant person must read and understand contents of this operation manual.

Operation manual should be kept accessible within the person who use the controllers / transmitters.

If you have problems which are not mentioned or can not be explained in this manual, please contact CLEAN local customer service center. They will be very glad to help you.

1.2 In Use

On any unmentioned use or the use that contradict with the technical parameters the operators should bear the responsibility.

Other conditions of right use include:

- Remarks and requirements stated in operation manual.
- Local safety regulations on safe operation.
- Information and warning of products that are used together with the transmitters in the contract. (chassis, electrode, etc.)
- Required operating environment and working condition.

1.3 Safety



The transmitters may only be carried out by trained experts.

Unqualified Transmitters should not be installed and used.

The transmitters should be used under the required working condition.

The transmitters should not be opened and repaired by clients themselves.

Modified transmitters should not be used. Manufacturers and suppliers do not bear responsibility for the damage and lost caused by modifying instruments without permission. Clients should bear all the risks.

This instrument is IP65 rated. Please use waterproof cable glands when you connect the cable. Also, please loose it when you open the cover. After connecting the cable, please tighten the cable conductor according to the following instruction with cable ties, or it will cause danger such as cable conductor or interface falls off when open the cover.

Please make sure to cut the power off when you open the cover to carry on any operation.

2 PRODUCT OVERVIEW

2.1 Product Features

CLEAN DO3000/DO5000/DO5500 Controller/Transmitter is used to measure Dissolved Oxygen and Temperature value.

The transmitters can be panel-mounted. They can be used as monitor in water treatment, controller in electrolytic water cleaning, in chemical industry, in food process, in cleaning water or waste water treatment and in neutralization process.

- Standard 1/4 DIN casing (2000/3000), Double high impedance input (5000/5500), easy installation.
- IP65 rated, waterproof and anti-gas, applicable in extreme conditions.
- High protection against electromagnetic interference.
- Menu-driven program that simplifies set-up.
- Built-in memory backup to ensure that setup parameter and calibration information are not erased or power -off condition.
- Scaleable isolated 4-20mA Outputs
- Temperature value offset adjustment.
- Two relay circuits, users can select high-low control freely. Separately adjustable high and lowset-point hysteresis (dead bands) prevent chattering of relays around the set points.
- LED indicators monitor control status from a distance.
- Large LCD, with high luminance LED backlight.

3) Returned setting data (public), suppose the unit ID code is 01

01	03	XX	Data	CRC value
Unit ID code	command	Number of data 1 byte (28 bytes)	28 bytes	The last 2 bytes

The definition of data part:

Relay 1:

1,2	3	4	5,6	7	8
ON integer	Decimal point	unit	OFF integer	Decimal point	unit

Relay 2:

9,10	11	12	13,14	15	16
ON integer	Decimal point	unit	OFF integer	Decimal point	unit

Relay 3:

17	18	19,20
Relay type	Cleaning second(s)	Cleaning interval(hours) 2bytes integer

Relay 3:

21,22	23	24	25,26	27	28
The transmitter 4mA corresponding value (2bytes integer)	Decimal point	unit	The 20mA corresponding value(2bytes integer)	Decimal point	unit

4) Returned setting data (private), suppose the unit ID code is 01

01	03	XX	Data	CRC value
Unit ID	Command	Number of the data		The last 2 bytes

Analyze on the data:

Byte	1,2	3	4
Analyze	The DO value integer	decimal point	unit

Note: 7FFF is outranged, 8000 is below range.

Decimal point of the third byte: 01 is 1 decimal place; 02 is 2 decimal places.

Unit of the fourth byte: 14 is mg/L, 19 is %

Byte	5,6	7	8
Analyze	The temperature value integer	Decimal point	unit

Temperature value: 7FFF is outranged, 8000 is below is range.

Byte 7: The decimal point of temperature 01 is a 1 decimal place.

Byte 8: 11 is °C, 12 is °F

Byte 9,10 ,1,12 are reserved bytes.

Byte 13 and 14 are the current transmission output value (integer). The default is 2 decimal places, unit is mA.

Byte 15 is the status of the Relays, 0 is disconnect, 1 is closed. The first 5 figures are independent bits. The sixth figure is Relay 3, the seventh figure is Relay2, the eighth figure is Relay 1.

2) Returned Calibration data: suppose the ID code of the unit is 01

01	03	OF	Data	CRC value
Unit ID	Command	1 byte (fix the number of data as 15 here)	15 bytes data	The last 2 bytes

The definition of data part:

Calibration status of Byte 1: the first 7 figures are independent bits. The 8th figure is calibration mark. 0 refers to without calibration, 1 refers to calibration done.

Byte 2 and 3 are the offset integer of the DO sensor. Default as no decimal point and the unit nV.

Byte 4 and 5 are the sensor slope, unit defaulted is %, 6 and 7 are independent bits.

Byte 8,9,10,11,12,13,14 are reserved bytes.

2.2 Technical Parameters

Model		DO2000	DO3000	DO5000	DO5500
Dissolved Oxygen	Range	0.0-400.0% , 0.00-40.00 mg/L			
	Resolution	0.1% , 0.01 mg/L			
	Accuracy	±0.2% F.S.			
	Salinity Compensation	0.0-40.0 ppt			
	Temp. Compensation	0.0-50.0 °C			
Temperature	Pressure Compensation	600-2000 mBar			
	Range	-10.0-110.0 °C			
	Resolution	0.1 °C			
	Accuracy	±0.3 °C			
	Temperature Sensor	22 K			
Signal Output	Temp. Compensation	Automatic			
	Signal Output	4-20 mA (Adjustable)			
	Current Accuracy	1% F.S.			
Data interface	Load	< 500 Ω			
	RS485				MODBUS Protocol
Relay Output	On/Off			2 SPST Relays	
	Output			2.5A 230VAC	
	Cleaning/Alarm Relays			1X 2.5A	
Others	Power	85-260 VAC or 24 VDC			
	Working Temperature	0 - 60 °C			
	Humidity	< 90%			
	IP Rated	IP65			
	Installation	Panel Mounting			Wall Mounting
	Dimensions	108(H)X108(W)X158(D)mm			158×188×108
	Panel Cut Size	94.5X94.5mm			
Weight	0.5kg			0.7 kg	

2.3 Measurement & Control System

Typical measurement system includes:

- Dissolved Oxygen on-line transmitter
- Dissolved Oxygen electrode with Pt1000 temperature sensor
- Suitable Dissolved Oxygen measurement cable
- Immersion, flow or processing parts
- Terminate control parts, e.g. Pump or valve
- 4~20mA output current to connect with recording instrument

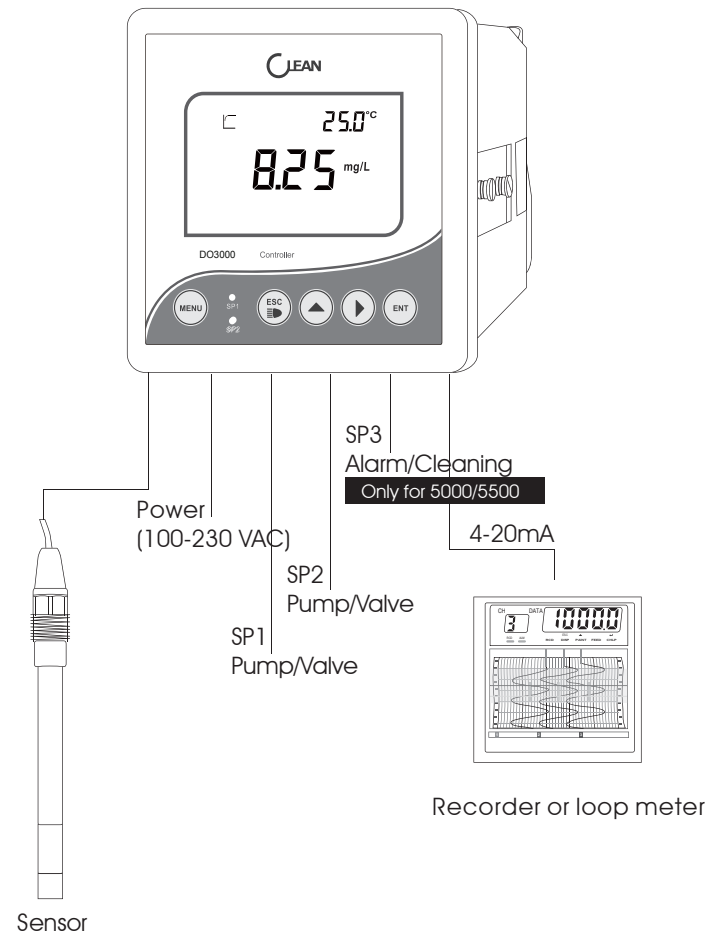

5. Analyze on the error data from the Console computer

1) No responding from Console computer

- Wrong sending address from the Host computer
- Receive time out. Timing when the Console computer receives the first data. The receiving will stop if the received data is less than the required command bytes (5 bytes) when the second system is interrupted.
- Host computer command bytes exceeding. Command will be invalid if the received command bytes in the receiving time are more than required. If the command sending from the Host computer is too frequent also leads to the same problem. Suggest the interval of the Host computer command sending be more than 0.5 seconds.

2) Returned Error code from the Console computer

Returned Error code from the Console computer is 5 bytes. The command from the Host computer and the Error code share the same beginning of 8, for example:

Address	Host computer command +0X80	Error code	CRC calibration
1 byte	1 byte	1 byte	2 bytes

The Error code can be classified as the following 4 circumstances:

- Error in command: The command from the Host computer is for example 01 05 01 E2 90 instead of 03.

The Console computer will return 01 05+80 81 82 F0

Command Error→01 85 81 82 F0

- Error in Command object. Available command object: 01. 02.03.04. If 01 03 07 61 32

the console computer will return: 01 03 +80 82 C1 51

Command object Error: 01 83 82 C1 51

- Error in CRC calibration code: If 01 03 01 AA BB(correct code: 01 03 01 E1 30)

the console computer will return: 01 03 +80 83 00 91

CRC calibration code Error: 01 83 83 00 91

- Unit not in the measurement condition, specially refers to when there is no mistake from the Host computer command, however, the Console computer is not in the correct measurement condition cause the failure of uploading the measurement results. For example:

Console computer returns: 01 03+80 80 40 90

Unit not in the measurement condition: 01 83 80 40 90

6. Analyze on the correct data from the Console computer

Note: The lower byte is behind the high byte in all returned integer data.

The returned data from the Console computer can also be classified in 4 circumstances as the Host computer.

1) Returned floating data: suppose the Unit ID code is 01

01	03	Number of data	Data	CRC value
Unit ID	Command	1 byte (fix the number of data as 15 here)	15 bytes data	The last 2 bytes

6 PROTOCOL

1. General Introduction

The unit adopts the RS-485 Modbus Protocol. The communication distance is as long as 1200m by merging 1-200 units in one communication line. Range of the ID code can be from 001-200. Communication baud rate range 1200, 2400, 4800,9600,19200. Data format can refer to the Modbus RTU format.

2. Composition of the communication command: Command from the Host computer

Console computer address(ID code)	Command code	Command object	CRC (Calibration)
1 byte	1 byte	1 byte	2 bytes(High in front)

3. Console computer address and the unit (ID code of the Console computer)

Command code: 03 is fixed here to read the contents from the register
Command object: the data format of the Host computer need to read from

Command	Object	Explanation of the data
01	Floating data (measured data)	The measured data, include the output current and the status of the Relays
02	Calibration data	The zero point, slope, calibration point, etc of the electrode after the calibration done
03	Parameter setting 1	The public part of the setup data
04	Parameter setting 2	The exclusive part of different units

4. The complete command from the Host computer (suppose the Console computer address is 01)

Console computer address	Command Code	Command Object	CRC Calibration	Explanation of the data
01	03	01	E1 30	reading the floating data
01	03	02	A1 31	reading the calibration data
01	03	03	60 F1	reading the parameter setting(public)
01	03	04	21 33	reading the the parameter setting(private)

2.4 Appearance

2.4.1 Display



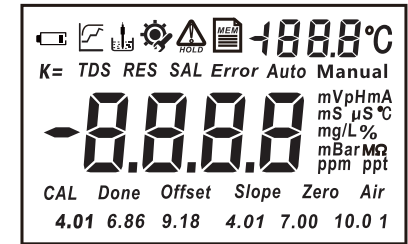

- Measuring Status-Calculating
- Measuring Status-Stable Value
- Electrode inserted display
- Setup display
- Offset - Electrode Offset
- Slope - Electrode Slope
- Done - Calibration Done
- g/L, °C, mg/L, mA, mBar - Unit of Measurement
- K= - Cell Constant



2.4.2 Display Character Table

SEN	Sensor	SL1	Slope 1
NA	nA output of electrode	SL2	Slope 2
SLP	Sensor slope	CHr	4-20mA Current output
EC	Temperature compensation	rLY1	Relay 1
PrE	Atmospheric pressure	rLY2	Relay 2
PrO	Process pressure	SAVE	Save
SAL	Salinity	Err	Error
CAL	Calibration mode	ON	On
SEt	Set up mode	OFF	Off
UNt	Unit	NO	NO
OSP	%	YES	YES
OC	mg/L	OUr	Temperature over range
EH22	Temperature sensor 22K	Udr	Temperature under range
COd	Password	FULL	Full data storage
dEF	Factory default	OUEr	Over measurement range
OF5	Offset	UNdr	Under measurement range

2.4.3 Key Panel

Key	Description
	Menu Key In measuring status, press the key once into Calibration mode In calibration or Set up mode, Press the key back to measuring status
	Escape Key Press and back to previous screen display in Calibration or Set Up mode Back light on and off switch in measurement status
	Up Arrow Key In measuring status, press the key into "Set Up Status Review" mode, press again to check each set up status. In SET UP mode, press to select items and to adjust set value. In Menu mode, act as forward cycle key
	Right Arrow Key In measuring status, press the key to change measurement mode In SET UP mode, press to select digits of value In Menu mode, act as backward cycle key
	Confirm Key Confirm the selection

2.4.4 LED Indicator

LED Indicator

SP1/ SP2 LED light-on shows the relevant relay is in working status.

5.14 Current Setup Status Review

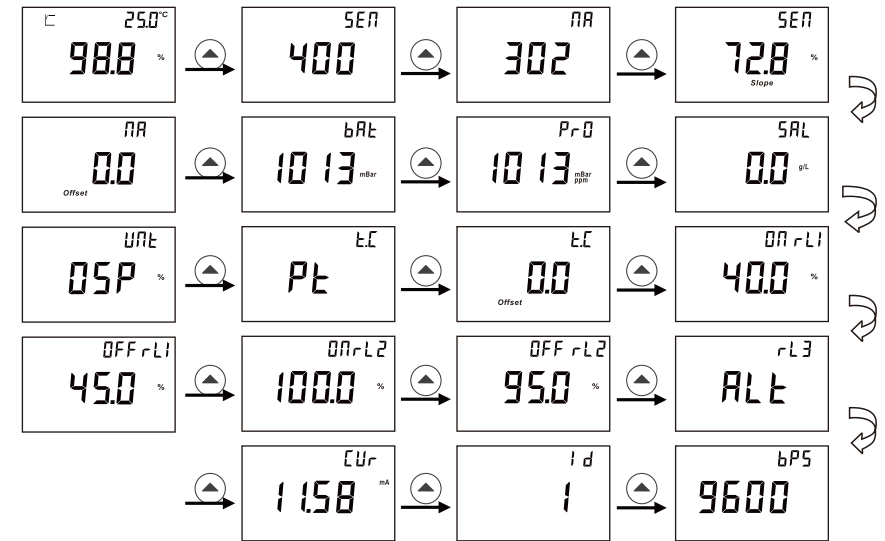

- In measurement mode, press ▲ key to review each setting form P-01 to P-13 .
- Press **MANU** key to go back to measurement mode.

5.12 P12 Password

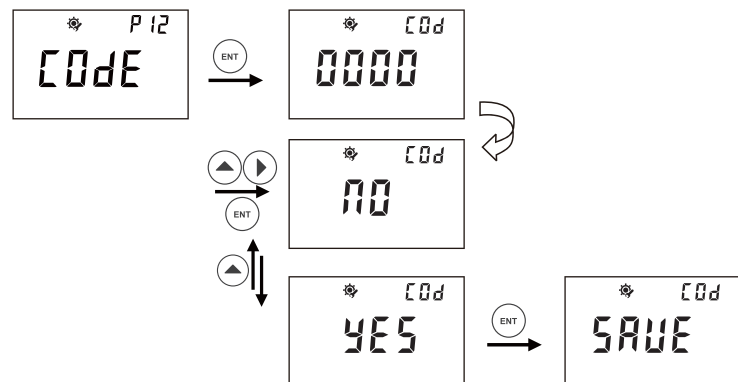

- In P-12, you can set up password to prevent anyone from changing your settings. Please refer to above description steps to set up P-12
- You can go to next parameter setting by pressing ▲ ►, or press **MENU** key to quit and go back to measurement mode.
- Factory default: 0000

5.13 P13 Factory Defaults

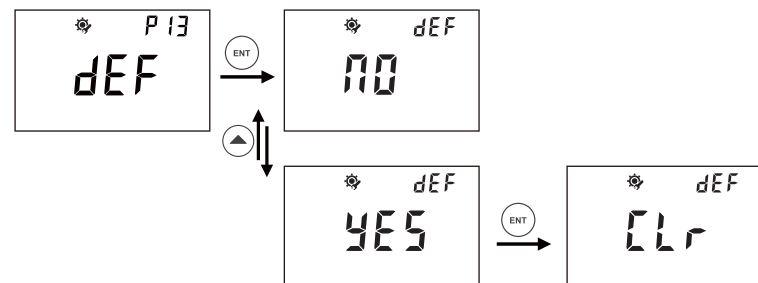

- In P-13, you can select to change factory defaults or to revert to factory default status. Please refer to above description steps to set up P-13.
- You can go to next parameter setting by pressing ▲ ►, or press **MENU** key to quit and go back to measurement mode.

2.4.5 Model and Menu

	DO3000	DO5000	DO5500
Electrode Factor	P-01	P-01	P-01
Atmospheric Pressure	P-02	P-02	P-02
Process Pressure	P-03	P-03	P-03
Salinity	P-04	P-04	P-04
Display unit	P-05	P-05	P-05
Temperature Offset	P-06	P-06	P-06
Relay 1	P-07	P-07	P-07
Relay 2	P-08	P-08	P-08
Relay 3		P-09	P-09
Current output	P-09	P-10	P-10
485 output		P-11	P-11
Password	P-10	P-12	P-12
Factory Defaults	P-11	P-13	P-13

* This manual is base on 5000 menu

2.5 Menu Preview

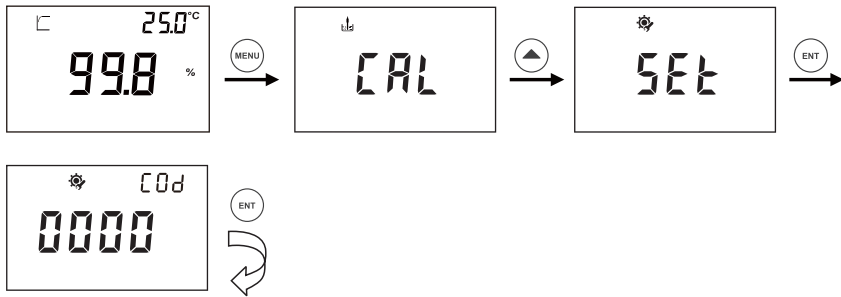

- In measurement mode, press **MENU** key to enter calibration step, and then, press ▲ key to enter set up process.
- Press **ENT** key to pass through, if you have not set up password.

5.11 P11 RS485 Output Only in 5000/5500

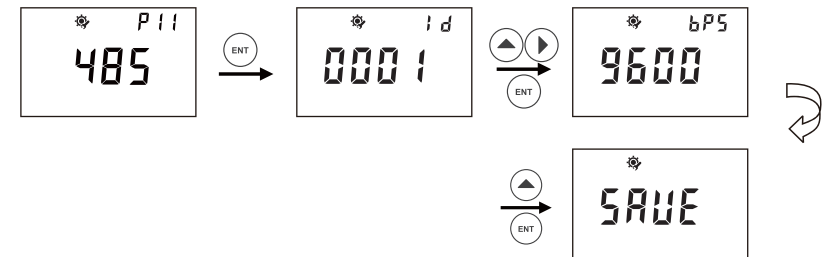

- After entering P-11, you can press ▲ ► to set the ID of the protocol address and press **ENT** to confirm. ID range can be set from 01 to 200.
- You can press ▲ to set the protocol rate you need and confirm by pressing **ENT**.



P01 Electrode Factor

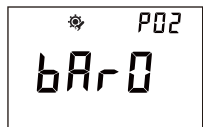

P02 Atmospheric Pressure

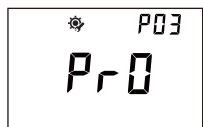

P03 Process Pressure



P04 Salinity



P05 Display Unit



P06 Temperature Offset

5.10 P10 Current Output

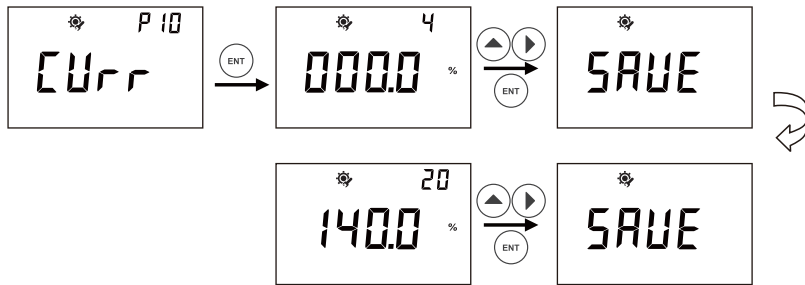

- In P-10 you can set up current output for measurement valve for advanced application.
- After entering P-09, the figure 4 on top right corner represents transmitting 4 mA out for below set value (000.4%). You can press ▲ ► to set a specific value you need to transmit 4 mA for your application.
- The figures 20 on top right corner represent transmitting 20 mA out for below set value (200.0%). You can press ▲ ► to set a specific value you need to transmit 20 mA for your application.
Please refer to above description steps to set up P-09.
- You can go to next parameter setting by pressing ▲ ►, or pressing **MENU** key to quit and go back to measurement mode.

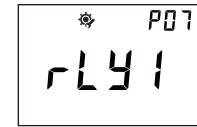

P07 Relay 1

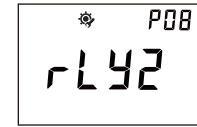

P08 Relay 2

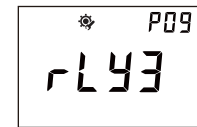

P09 Relay 3 (SP3)

Only for 5000/5500

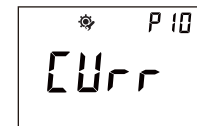

P10 Current Output



P11 RS485 Output

Only for 5000/5500



P12 Password



P13 Factory Defaults

3 INSTALLATION

3.1 Installation

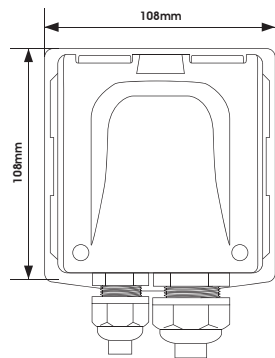
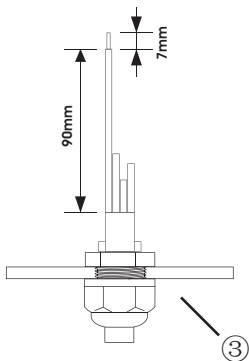
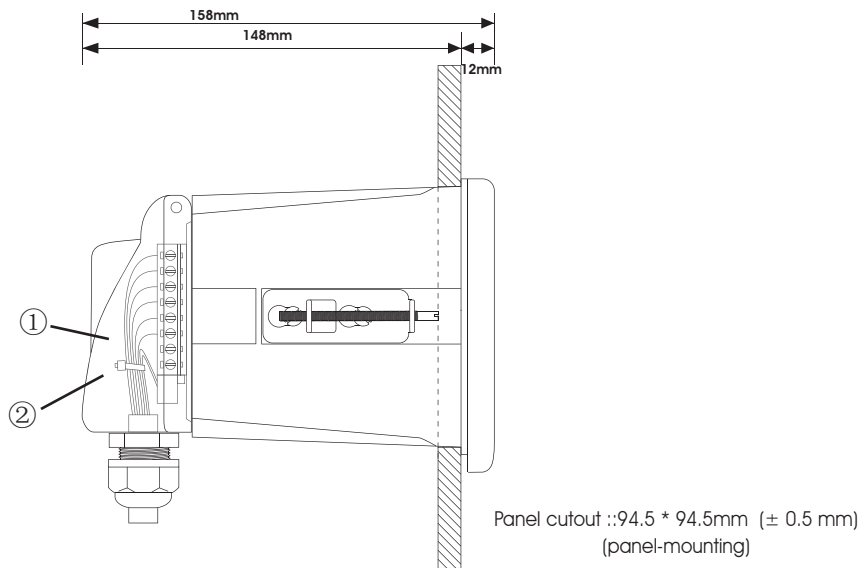

- ①. Cable (Recommended stripping length for cables is at least 90mm, please use 0.5 to 1 square meter's wire)
- ②. Cable ties
- ③. Waterproof cable glands

5.09 P09 Relay 3 (SP3)

Only for 5000/5500

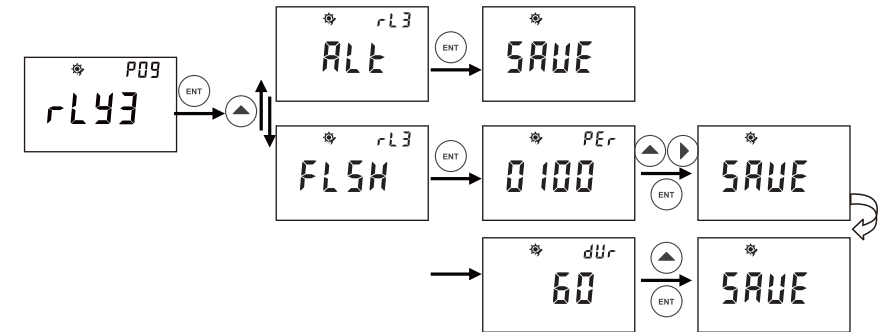

- In P-09, you can set up Relay 3 (SP3), also called the Cleaning/Alarm Relay.
- After entering P-09, you can press ▲ to set the ALT and FLSH.
- By pressing ENT to set the ALT function, the unit will then alarm if the other two Relays have any operation.
- FLSH refers to the Cleaning function. The cleaning frequency can be set per each 0-1000hours and 0-120 seconds for the time of duration.
- You can press ▲ ► to set the specific hours you need to clean per each time. Press ▲ to set the duration time per each cleaning.
- Please refer to above description steps to set up P-09.

Note: The Cleaning/Alarm Relay can also be set as manual in the measuring mode as below:

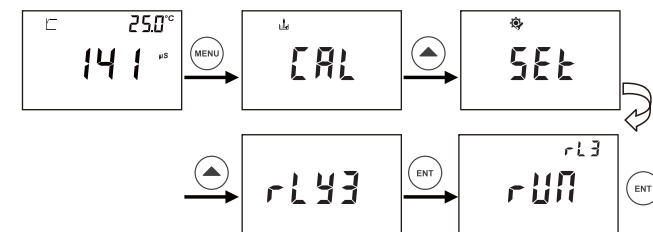

- After entering the measuring mode, the screen will twinkle and display "RUN". The twinkling will stop by pressing ENT and the unit starts to clean/alarm. This function is only available for the current model.

5.7 P07 Relay 1

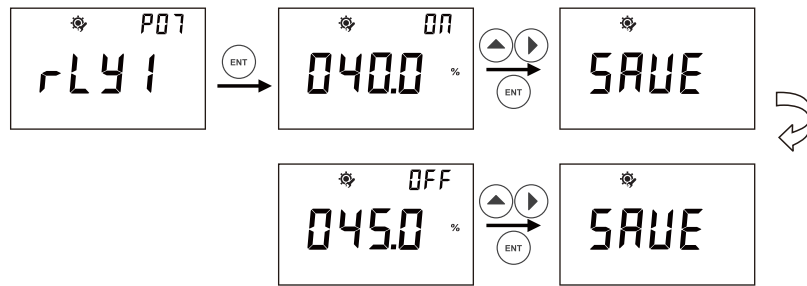

- In P-07, you can set up Relay 1 (SP1): On-Point and Off-Point.
- Please refer to above description steps to set up P-07.
- You can go to next parameter setting by pressing ▲ ►, or press **MENU** key to quit and go back to measurement mode.

5.8 P08 Relay 2

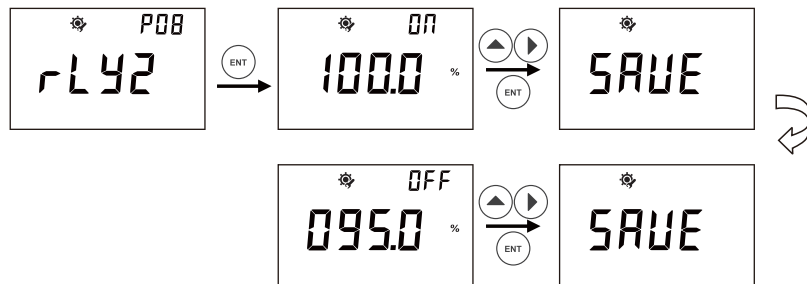

- In P-08, you can set up Relay 1 (SP2): On-Point and Off-Point.
- Please refer to above description steps to set up P-08.
- You can go to next parameter setting by pressing ▲ ►, or press **MENU** key to quit and go back to measurement mode.

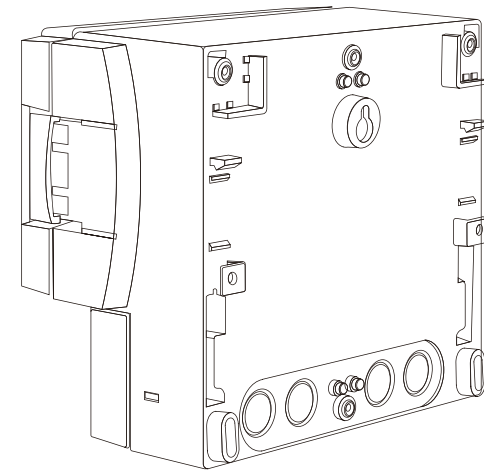
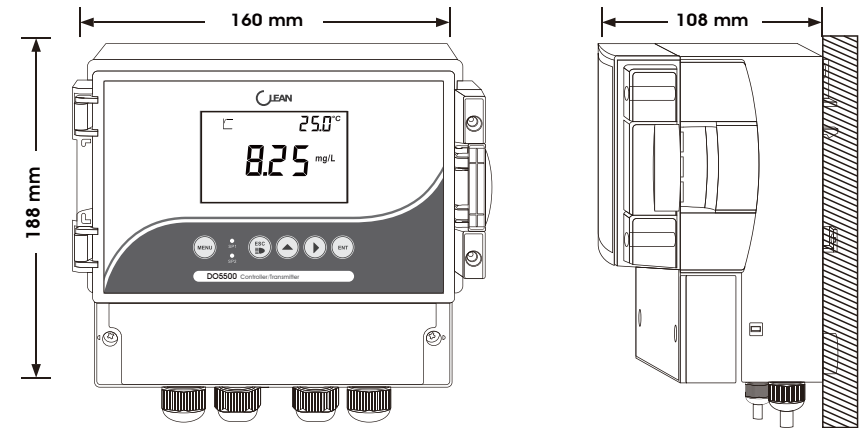

3.2 Connection Diagram

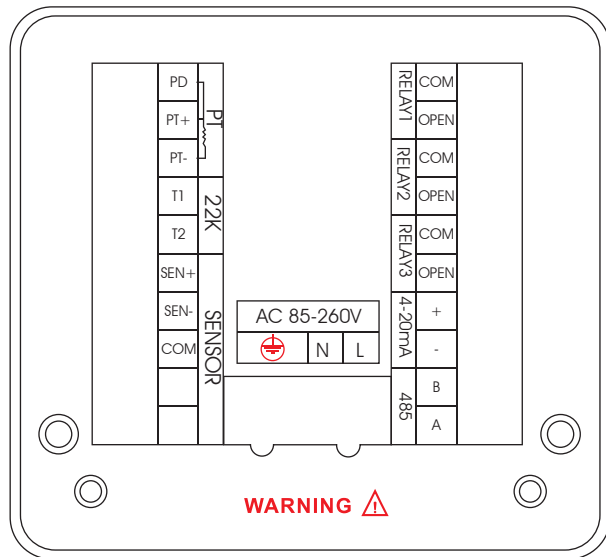

Terminal	Function	Terminal	Function
PD	Pt1000 drive positive	COM(RL2)	COM(RL2)
PT+	Pt1000 signal positive	OPEN(RL2)	OPEN(RL2)
PT-	Pt1000 signal negative	COM(RL3)	COM(RL3)
T1	T1	OPEN(RL3)	OPEN(RL3)
T2	T2	4-20mA (positive)	4-20mA output, positive
SEN+	Sensor +	4-20mA(negative)	4-20mA output, negative
SEN-	Sensor -	485(B)	485 output
COM		485(A)	485 output
COM(RL1)	COM(RL1)	L	85-260V power input
OPEN(RL1)	OPEN(RL1)	N	Neutral
		⊕	Earth

5.6 P06 Temperature Offset

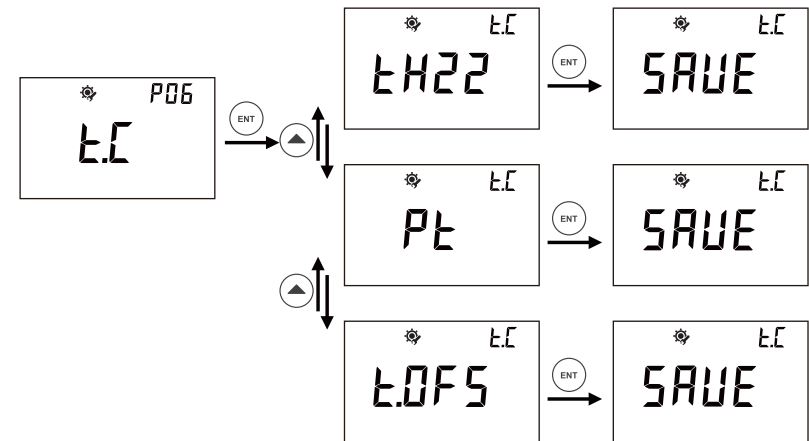

- In P-06, you can set up temperature offset value for better measurement results.
- Please refer to above description steps to set up P-06.
- You can go to next parameter setting by pressing ▲ ► , or press **MENU** key to quit and go back to measurement mode.

5.4 P04 Salinity



- In P-04, you can set up Salinity concentration value for compensation to get the better measurement result.
- Please refer to above description steps to setup P-04.
- Factory default: 0.0 g/L, Range:0.0 – 40.0 g/L.
- You can go to next parameter setting by pressing ▲ ►, or press **MENU** key to quit and go back to measurement mode.

5.5 P05 Display Unit

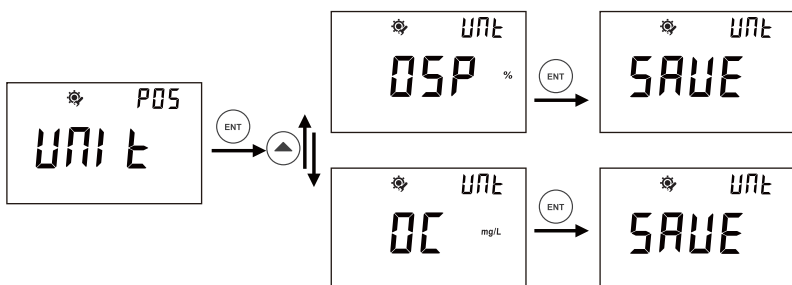

- In P-05, you can set up UNIT of dissolved oxygen concentration for your application.
- Please refer to above description steps to setup P-05.
- Factory default: %.
- You can go to next parameter setting by pressing ▲ ►, or press **MENU** key to quit and go back to measurement mode.

4 CALIBRATION

4.1 DO Sensor Calibration

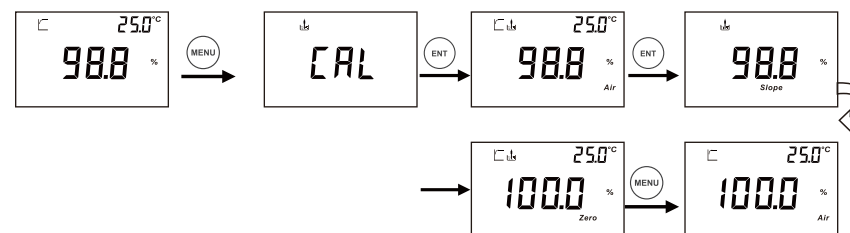

- In measurement mode, press **MENU** key to enter calibration step, and then, press **ENT** key to enter calibration process.
- First point calibration - 100% air calibration: put the sensor in air, after stable symbol shows up, press **ENT** key to confirm 100.0% saturated dissolved oxygen point. Then, automatically initiate second point calibration – 0% point calibration.
- If you don't need to calibrate 0% point, Press **MENU** key to go back to measurement mode.

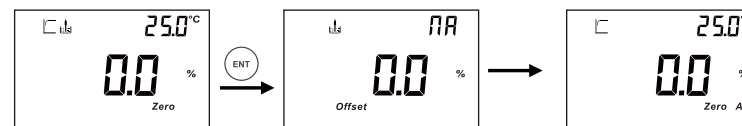

- Second point calibration – 0% point calibration: dip the sensor in standard solution, when the value is stable, press **ENT** key to confirm 0% point. Then, system go back to measurement mode.

5 SET UP

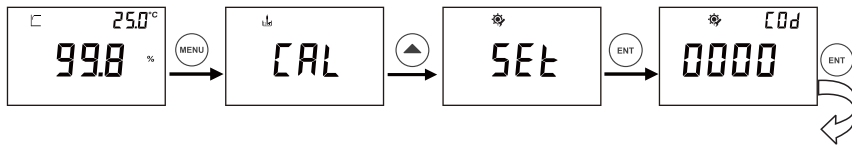

- In measurement mode, press **MENU** key to enter pH calibration step, and press **▲** to enter set up mode, then press **ENT** key to initiate set up process.

5.1 P01 Electrode Factor

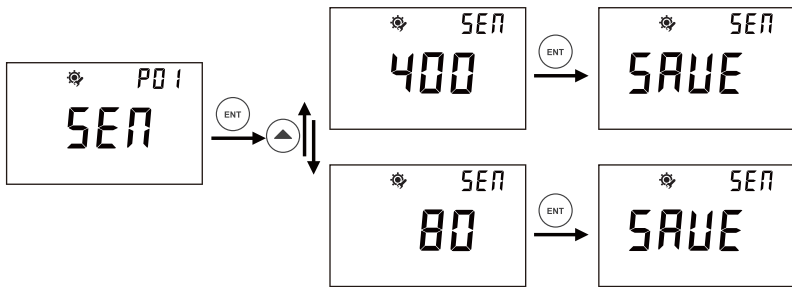

- In P-01, you can set up DO electrode factor for the equipped sensor for measurement application.
- Please refer to above description steps to setup P-01.
Factory default: 400 nA.
- You can go to next parameter setting by pressing **▲ ▶**, or press **MENU** key to quit and go back to measurement mode.

5.2 P02 Atmospheric Pressure



- In P-02, you can adjust Atmospheric Pressure value for compensation to get the better measurement result.
- Please refer to above description steps to setup P-02.
- Factory default: 1013 mBar, Range: 600 – 2000 mBar
- You can go to next parameter setting by pressing **▲ ▶**, or press **MENU** key to quit and go back to measurement mode.

5.3 P03 Process Pressure

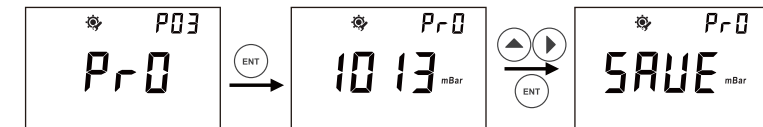

- In P-03, you can adjust Process Pressure value for compensation to get the better measurement result whenever the sensor is installed in the pipeline, flow cell or in the tank.
- Please refer to above description steps to setup P-03.
- Factory default: 1013 mBar, Range: 600 – 2000 mBar.
- You can go to next parameter setting by pressing **▲ ▶**, or press **MENU** key to quit and go back to measurement mode.

8 GENERAL INFORMATION

8.1 Warranty

CLEAN Instruments warrants this product to be free from significant deviations in material and workmanship for a period of one year from the date of purchase. If repair is necessary and has not been the result of abuse or misuse within the warranty period, please return to CLEAN Instruments and amendment will be made without any charge. CLEAN Instruments Customer Service Center will determine if product problem is due to deviations or customer abuse. Out of warranty products will be repaired on a charge basis.

8.2 Return Of Malfunction Instruments

Authorization must be obtained from CLEAN Instruments Customer Service Center to issue a RIR number before returning items for any reason. When applying for authorization, please include date requiring the reason of return. Instruments must be carefully packed to prevent damage in shipment and insured against possible damage or loss. CLEAN Instruments will not be responsible for any damage resulting from careless or insufficient packing.

Warning: Damage as a result of inadequate packaging is the User / distributor's responsibility. Please follow the guidelines below before transporting.

8.3 Guidelines Or Returning Unit For Repair

Use the original packaging material if possible, when transporting back the unit for repair. Otherwise wrap it with bubble pack and use a corrugated box for better protection. Include a brief description of any faults suspected for the convenience of Customer Service Center, if possible. If there are any questions, feel free to contact our Customer Service Center or distributors.